



Precautions

[WARNING]

1

Do not open or disassemble the cover to reduce the risk of electric shock.

2

Please wear safety equipment such as safety helmet during work.

3

Be sure to fix the safety chain on the product when installing and moving.

4

Please install the signs below for people to bypass when install the product on high truss.

5

The work should be done under the direction of approved specialist who is trained in safety and mechanical installations.

6

The brightness and color temperature before and after aging may be different.

Contents

Safety Information	1
--------------------------	---

Fixture Information

Fixture Information	3
Fixture Exterior View	4
Dimensions	5
Accessory Options	6
Technical Specifications	7
Photometry Data	8

Fixture Installation

Power Connection	9
DMX Connection	10

LCD Screen Instruction

Unlocking	11
Screen Instruction	12
Menu Tree	13
Main Screen by Mode	14
& Product Information	
DMX Mode	15
(Channel Change & Address Setup)	
User Mode	16
(Intensity & Color Temperature Adjust)	
Color Mode	17
(RGB & Hue & Saturation & White Adjust)	

Extra Function

Sleep Mode Function	18
RDM Function	
Dimming Speed Setup	
Master Function	19
Fixture ID Number Setup	20
Fixture Label Setup	

Error Information

Temperature Sensor	21
Network Connection	

Extra Information

Cross Fader	22
Color Macro	

Protocols

DMX Protocols	23
RDM Protocols	25



Product name.

A6-PLUS

- ⇒ Flat light source lighting fixture, which is mainly used in broadcast studio
- ⇒ Excellent light quality, and average CRI 95-98 / R9, R12 are CRI 90 or higher
- ⇒ Light that does not expose the light source, with less glare, evenly and extremely soft light distribution
- ⇒ High efficiency and light saturation by using Micro diffusing lens, and excellent photometric flatness
- ⇒ 2500~10000K color temperature control function
- ⇒ R, G, B Full Color LEDs are combined to create a scene for all acting parts and a variety of atmospheres
- ⇒ Support RDM network communication and various mode setting possible
- ⇒ Smart touch control method makes it easy and convenient to check all information at a glance
- ⇒ Long life, reduce maintenance costs and power consumption.

Fixture Exterior View



Dimensions

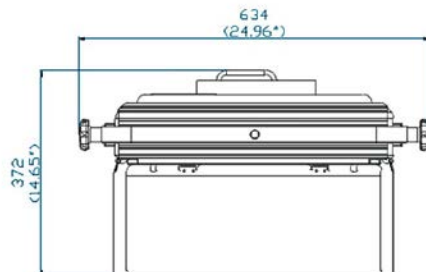
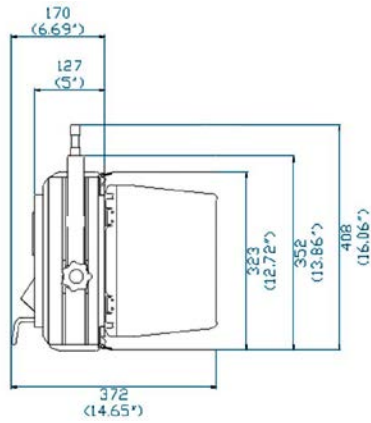
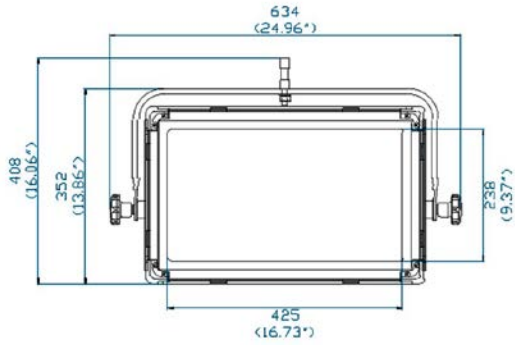

Accessory Options



Pole operation yoke

· Pan & Tilt



Soft box

· Detachable

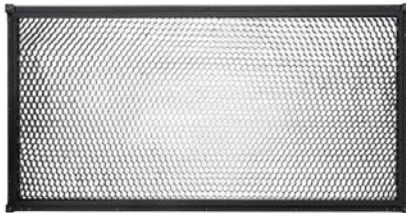

Honeycomb

· Detachable

Technical Specifications

LED Chip Type	0.5W 3030 PKG LED / 0.5W RGB 5050 PKG LED
Estimated LED Lifetime (hours)	50,000
White Light (K)	2,500~10,000 (VCT)
Full Color Light	Full RGB+W (4Color Gamut with Hue and Saturation Control)
Color Rendition (%)	CRI 97 / TLCI 97
Dimming (%)	0~100 (16-bit)
Light Aperture Size (mm/inch)	369 x 238 / 14.5 x 9.4
Beam Angle (°) (Standard)	135
Signal Control	5-Pin DMX In and Out
Individual Control	Smart Touch LCD Controller
Supported Protocol	DMX512 / RDM
(Optional) Supported Protocol	DMX512 Wireless / RDM Wireless
Remote Device Management	Supported
Channel Function	Dimming / CCT / Tint / RGBW / Cross Fader / Color Macro
Power Input Voltage	AC 100-240V / 50~60Hz
Power Consumption (W)	300
Ambient Temperature Operation (°C)	-20~45
Spigot Mounting (mm)	16 / 28
Tilt Angle (°)	+ / - 90
Body Dimensions (mm/inch) (WHD)	538 x 320 x 170 / 21.2 x 12.6 x 6.7
Full Dimensions with Manual Yoke (mm/inch) (WHD)	634 x 408 x 170 / 25 x 16.1 x 6.7
Body Weight (kg/lbs)	7 / 15.4
Full Weight with Manual Yoke (kg/lbs)	8 / 17.6
Protection Class	IP20

* This specification data is based on the aging state of the equipment, and the brightness and color temperature before and after aging may be different.

Photometry Data

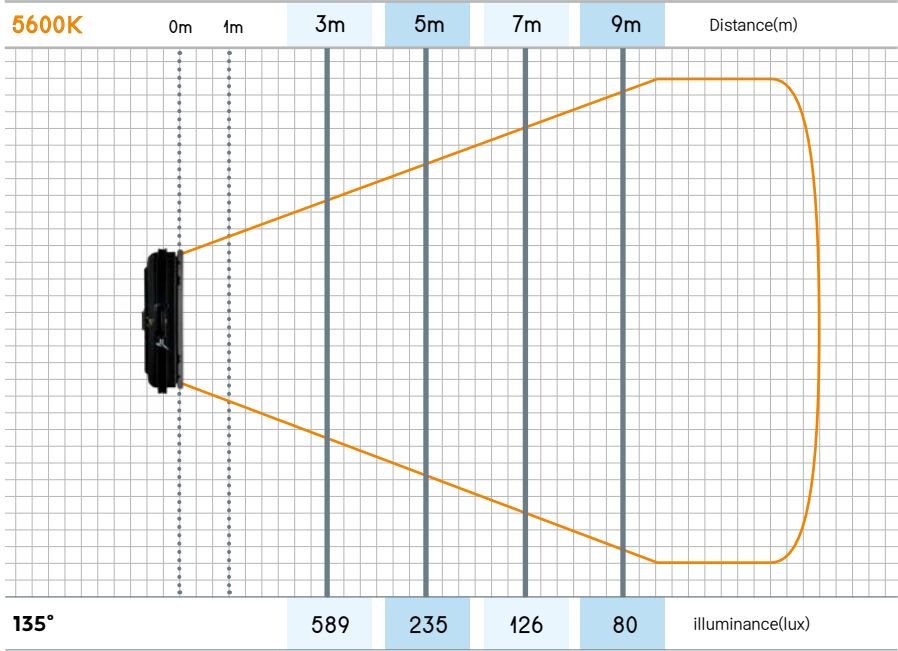

Power Connection

AC power at 100-240V, 50-60Hz

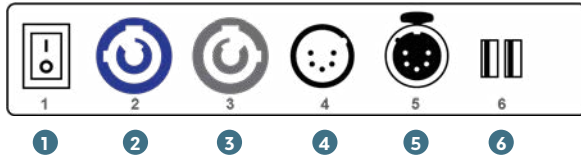

- | | |
|-----------------------|--|
| ① POWER ON/OFF SWITCH | ④ DMX IN |
| ② POWER IN | ⑤ DMX OUT |
| ③ POWER OUT | ⑥ USB PORT
(for ADMINISTRATOR ONLY) |

※ Do not connect USB without administrator's permission.

- ⚠ WARNING**
1. Observe the proper voltage rang.
 2. If power is supplied outside the range, noise may be generated from the SMPS.
 3. If the operating voltage is out of the proper voltage range, SMPS function may be degraded or damaged.

Power Pass-Thru : Based on operating voltage 240V and using the cable provided by ALPHA LITE.

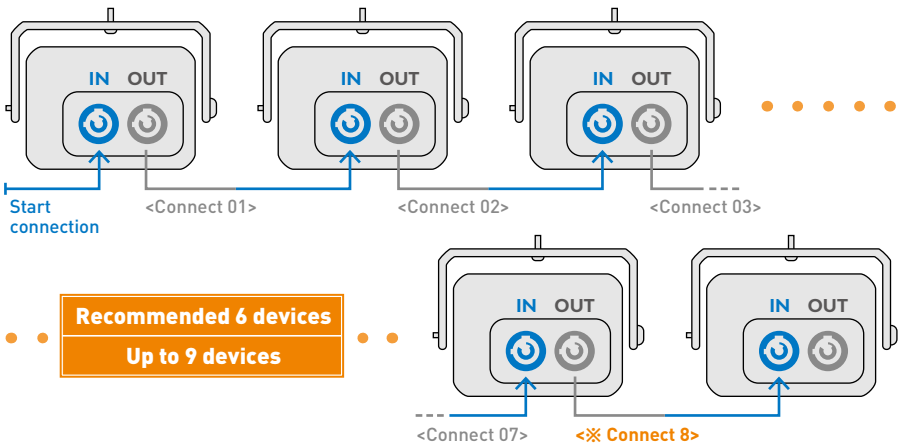

DMX Connection

3-pin or 5-pin XLR sockets are equipped for DMX input and output, depending on user needs.

Connect the controller to a lighting, or lighting fixture to other lighting fixture. If user uses a standard DMX controller, the DMX output of the controller can connect directly to the DMX input of the first fixture in the DMX chain.

User must use an adapter cable for connect the DMX controller to other XLR output.

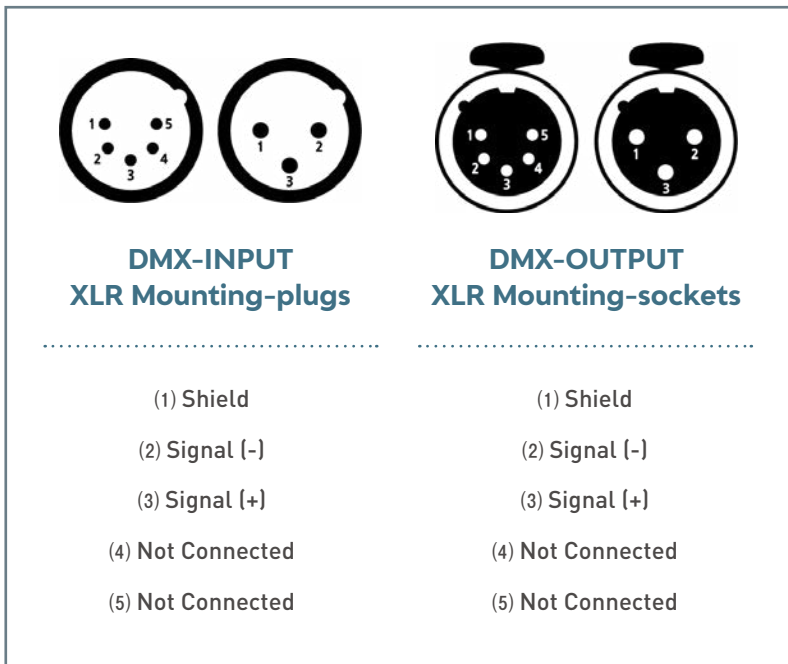

- ⚠ WARNING**
1. Connect the DMX output of the first lighting fixture in DMX chain to the DMX input of the next fixture.
 2. Connect one output to the input of the next fixture until all fixtures are connected.
 3. In the last lighting fixture, the DMX cable must be end with a terminator (120 Ω resistor) in DMX output signal (+, -).

Unlocking

When the fixture is turned on, the Smart Touch screen automatically locked. To unlock the touch screen, touch the finger icon (A) three times. If you do not touch for 30 seconds, the lock is reset.

[Main Screen (Locked)]

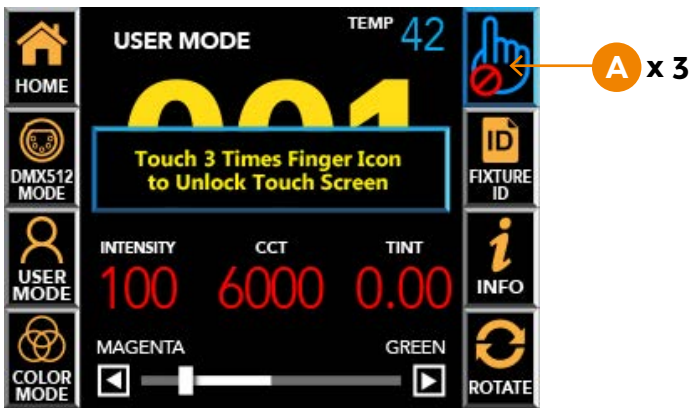

[Fixture ID Screen (Locked)]

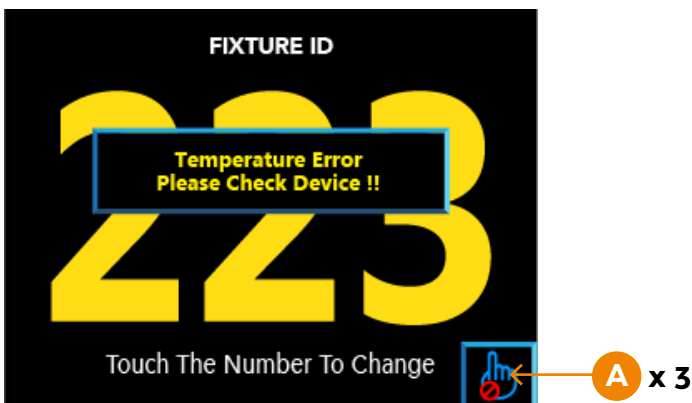

Screen Instructions

[Main Screen (Unlocked)]

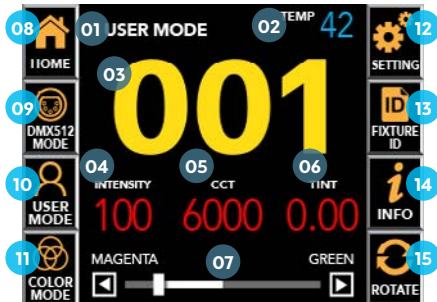

[Setting Screen]

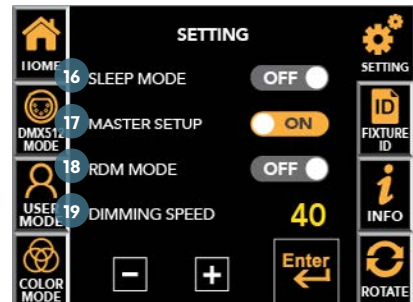

01	Current Mode	Display DMX MODE or USER MODE or COLOR MODE.
02	Current Channel Mode	Display current channel mode (only display on DMX MODE)
03	DMX512 Address	Display current DMX512 Address.
04	Brightness (Intensity)	Displays the brightness value(0~100%) of the equipment.
05	CCT (Correlated Color Temperature)	Displays the color temperature(2500~10000K) of the equipment.
06	Fixture Current Temperature	The current temperature of the instrument is detected and displayed in ° C.
07	Activated Function Control Bar	Adjust the selected function among Intensity, Color Temperature and Tint.
08	Home	Return to the main screen
09	DMX512 Mode & Address Setup	Set channel mode and DMX512 address
10	User Mode Setup	Set 'Intensity' and 'CCT' manually
11	Color Mode Setup	Set 'RGB' lighting color, 'Saturation', and 'Intensity'
12	Setting	Setting or changing the function of the equipment.
13	Fixture ID	Displays numbers for equipment management.
14	Equipment Information	Displays the help that describes the screen.
15	Screen Rotation	LCD screen is rotated 180° for each touch.
16	Sleep Mode Setup	Activate and deactivate LCD Auto off function
17	Master Setup	Activate and deactivate Master function
18	RDM Mode Setup	Activate and deactivate RDM function
19	Dimming Speed Setup	Set dimming speed

Menu Tree

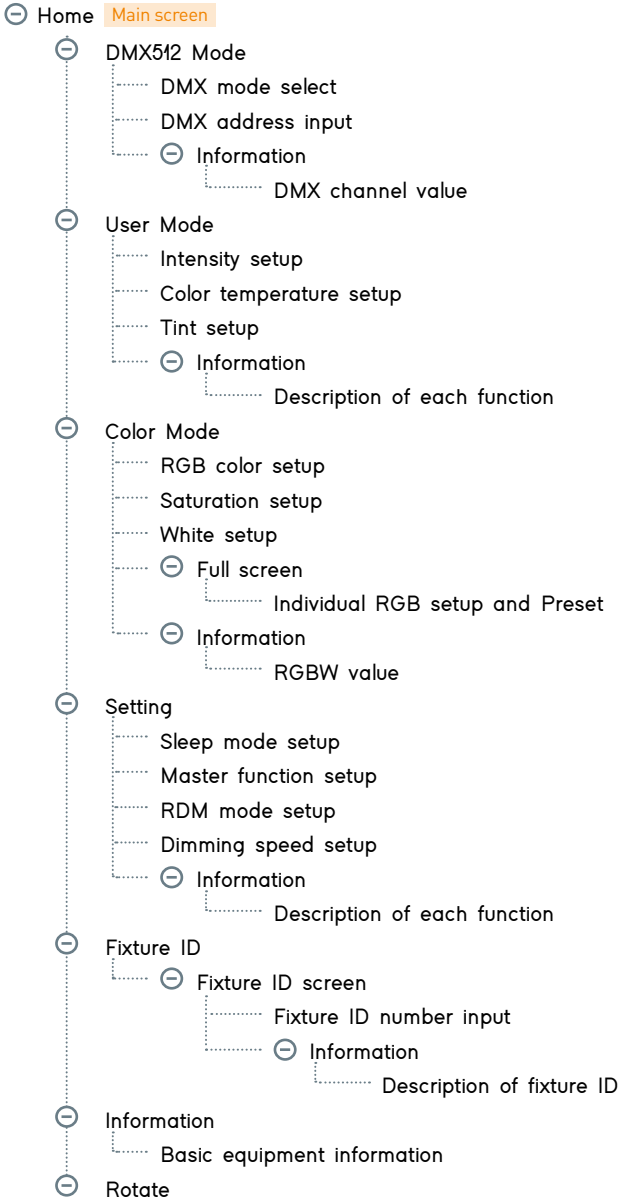

Main Screen by Mode & Product Information

001 Main Screen by Mode Information

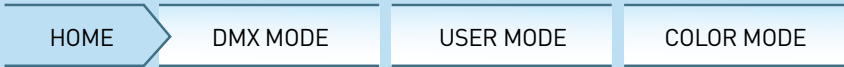

The current mode is displayed in the upper left corner of the main screen among DMX mode, user mode and color mode, and the DMX address number of the equipment is displayed in the middle with a yellow number. At the bottom, the current lighting value and fixture temperature are displayed, and some lighting value can be adjusted on the main screen by touching the value.

[DMX MODE]



[USER MODE]

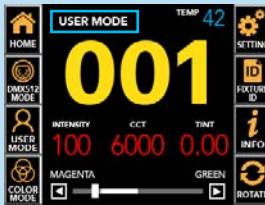

[COLOR MODE]



Product Information

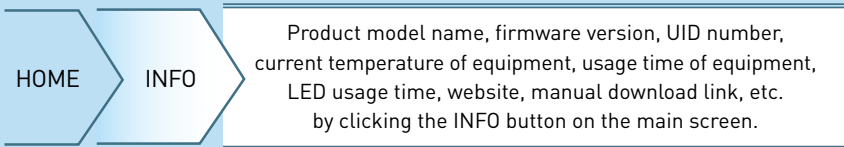

Each 'MENU' ▶ Touch the 'INFO' ▶ User can check the menu description and functions.

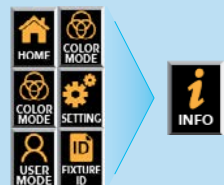

DMX Mode Channel Change & Address Setup

DMX MODE : It is used to adjust by DMX512 signal.

HOME

DMX512 MODE

Move to the DMX channel change screen.

In DMX512 MODE screen, user can select DMX channel mode on top tap. ▶ Input DMX512 address by pressing the number pad.

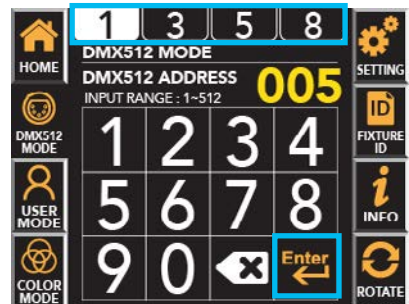
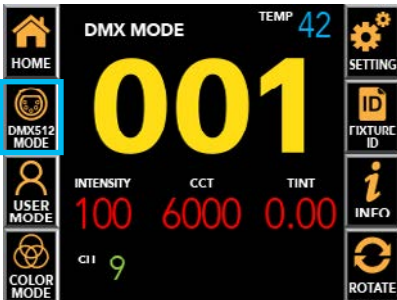

DMX512 MODE SCREEN

INFO

Displays each channel information and value.

※ To return to the previous screen, press the 'INFO' button again.

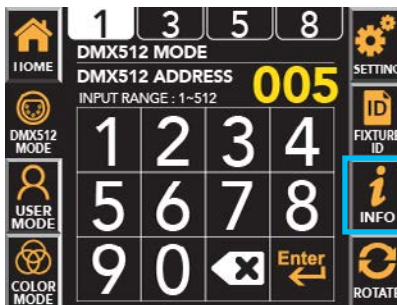

Information

- 1 [1 Ch Mode] : Dimming
- 3 [3 Ch Mode] : Dimming, CCT
- 5 [5 Ch Mode] : Dimming, CCT, Tint, Cross Fader, Color Macro
- 8 [8 Ch Mode] : Dimming, CCT, Tint, Cross Fader, Red, Green, Blue, White

* Support channels and features vary by product.

User Mode Setup & Intensity / CCT / Tint Adjust

USER MODE : It is used when the user directly manipulates the equipment.



USER MODE screen ▶ Touch what you want to change ▶ **Activated with orange** ▶ Adjust the value with touch or drag. Drag the activated bar close to the desired value, and then touch $\left[\pm \right]$ to set the exact value.

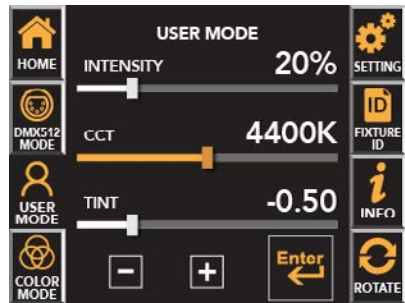
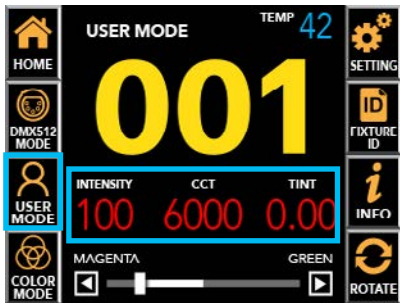

USER MODE SCREEN

INFO

Displays description of each function.

※ To return to the previous screen, press the 'INFO' button again.

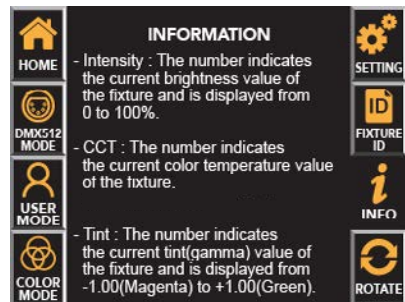
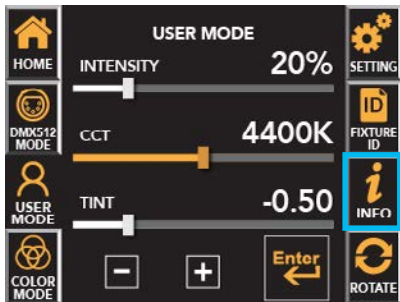

Information

- Intensity : The number indicates the current brightness value of the fixture and is displayed from 0 to 100%.
- CCT : The number indicates the current color temperature value of the fixture and is displayed from 2,500~10,000Kelvin.
- Tint : The number indicates the current tint(Gamma) value of the fixture and is displayed from -1.00(Magenta) to +1.00(Green).

Color Mode Setup & RGB / Hue / Saturation / White Adjust

COLOR MODE : It is used when the user directly manipulates the equipment.

HOME

COLOR MODE

HUE Brightness Control ▶

More to the individual RGB adjustment preset save screen.

Change screen by selecting 'COLOR MODE' button ▶ Activated with orange ▶ Adjust the value with Touch or Drag.

- Individual RGB value adjustment and saving preset (#1~9) can be specified through the [] button.
- Fine adjustment of RGB values and the number of presets can be changed through the up, down, left and right arrows.

After adjusting the desired value, Enter ▶ It returns to the COLOR MODE screen.

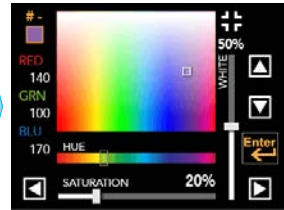
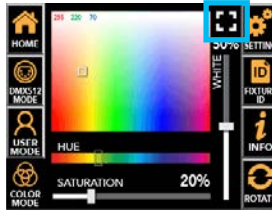
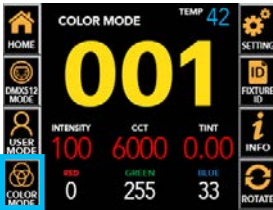

COLOR MODE SCREEN

INFO

Displays description of each function.

※ Press the INFO button again to return to the 'COLOR MODE' screen.

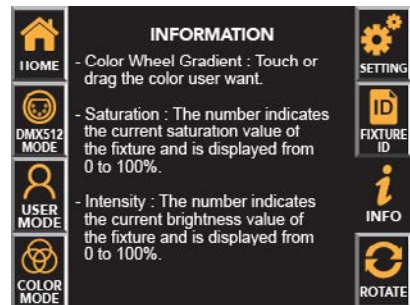
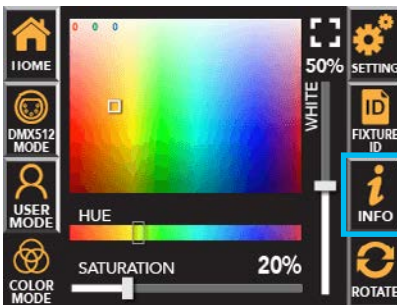

information

- Color Wheel Gradient : Touch or drag the color user want
- Hue : Drag and select the Hue user want.
- Saturation : The number indicates the current saturation value of the fixture and is displayed from 0 to 100%.
- White : The number indicates the current White LED brightness value of the fixture and is displayed from 0 to 100%.

Extra Function

- Sleep Mode / Master / RDM / Dimming Speed

HOME

SETTING MODE

Move to a screen where you can make additional settings other than the main icon.

On the setting screen, touch ON/OFF of an item to be changed among sleep mode, master, and RDM functions. ▶ **Activated with orange** ▶ You can change the settings.

- DIMMING SPEED SETUP can be activated by touching, and press **+**, **-** to adjust the value.



SETTING SCREEN

INFO

Displays description of each function.

※ Press the INFO button again to return to the setting screen.

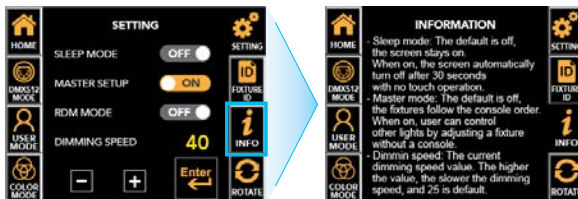

Information

- **Sleep mode setup (Default=Off)** Set the feature that the screen automatically turn off after 30 seconds, if there is no touch operation. If Off, it is always on while power is on.
- **Master setup (Default=Off)** Set the feature that allows user to synchronize and control all fixtures without a console connection. If Off, the DMX signal will follow.
- **RDM setup (Default=On)** Set the feature that enables bi-directional wireless communication through RDM equipment. If Off, this equipment will not be searched on RDM equipment.
- **Dimming speed setup** The number indicates the current dimming speed value of the fixture and is displayed from 0 to 40. The higher the value, the slower the dimming speed, and '15' is default speed

Extra Function

- Sleep Mode / Master / RDM / Dimming Speed

Master settings

- The master slave function allows you to synchronize and control all light fixtures connected through the DMX signal with a master fixtures without a console connection.
- If a problem occurs in the console or communication on line, it is possible to control the color only with lighting fixture.
- Main screen ► Setting ► Touch MASTER SETUP, the function turns on. (2 Touch)
- Functions available with one setting of the first lighting fixture.

[Main Screen]

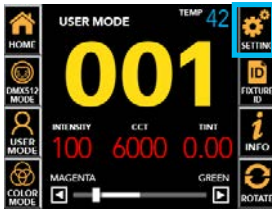

[Fixture ID Screen]



ex

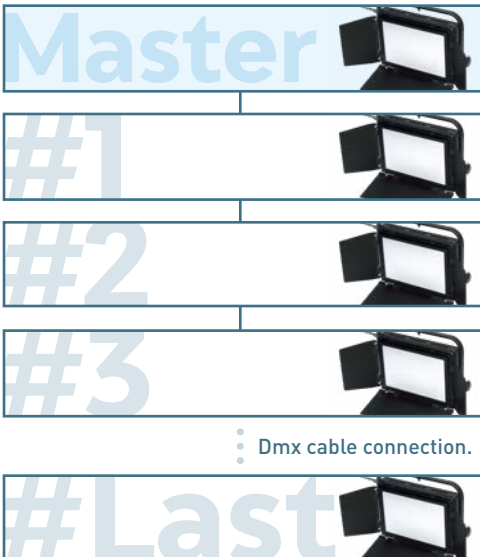

- Remove 'DMX in' cable.
- Set '**Master Enable**'
- Set the same channel mode.
- Operation After setting.

- Connecting 'DMX in & out' cable.
- Set '**Master Disable**'
- Set the same channel mode.
- No operation after setting.

Fixture ID & Label Setup

HOME

FIXTURE ID

Move to fixture management number setting screen.

Touch a large number on the FIXTURE ID screen. ▶ Move to the instrument ID input screen where numbers can be changed. ▶ Enter the desired number 001 to 9999 on the object ID input screen. ▶ Go to the screen displaying the entered value. ▶ Go back to the main screen, touch HOME icon

[Main Screen]

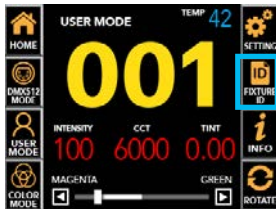

[Fixture ID Screen]



[Fixture ID Input Screen]

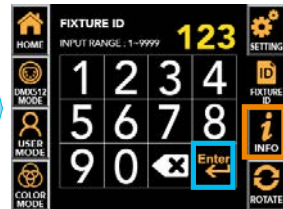

Fixture ID Input Screen

INFO

Check how to set the function

※ It is the number value 001 to 9999 for the management of the light fixture can be changed by manual or RDM device.

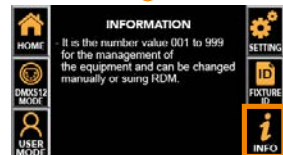

[Fixture Label Setup]



[Changing the label of the device through RDM]

《 The label of the device is basically the model name, and it can be changed through RDM communication, but it can't be changed through the Smart Touch LCD 》

Enter the device name and the management number in the 'Device Label' field. ▶ The entered contents are displayed in the upper left corner.

- The fixture ID is displayed in 3 or 4 digits from automatically recognized 4 digits in contents.
- If user do not enter any number, the fixture ID is displayed as '001'.

	ex 1	ex 2	ex 3	ex 4	ex 5
Input(Device Label in RDM)	BASE123	BASE1234	BASE12345	BASE	STUDIO13-23
Fixture Label(in Fixture)	BASE123	BASE1234	BASE12345	BASE	STUDIO13-23
ID Number(in Fixture)	123	1234	2345	001	023

Error Information

Temperature Sensor

Detects the temperature of the current fixture(LED, housing) and displays it on the Smart Touch LCD screen.



If it exceeds 85°C, the actual LED output will be 0%, and

“Temperature Error!!”

“Please Check Device!!”

will be displayed.

The error messages are only displayed on the main screen and the fixture ID screen. Even if the temperature falls to the normal range, It does not disappear.

In this case, normalize the temperature of the equipment and restart it.

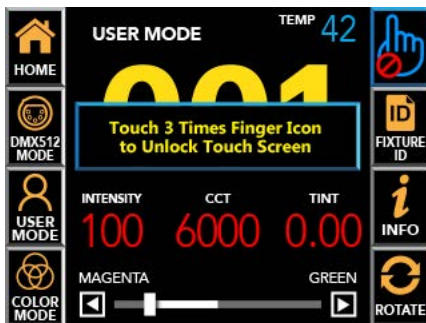

Network Connection

When the DMX512 network connection is lost, the DMX512 address number on main screen and the fixture ID screen blinks. Check the connection and reconnect.

Cross Fader & Color Macro

Cross Fader

[In 4 or 7 channel mode]

- When the DMX value of channel 3(Cross Fader) is 0, the set color temperature(CCT) is displayed by channel 2.
- When the DMX value of channel 3 is 255, only Red(channel 4), Green(channel 5), Blue(channel 6) and White(channel 7) color values are displayed.
- As the DMX value of channel 3(Cross Fader) increases, RGB and White values become darker.
- The DMX value of channel 3 adjusts relatively the brightness ratio of channel 2 and channel 4~7.

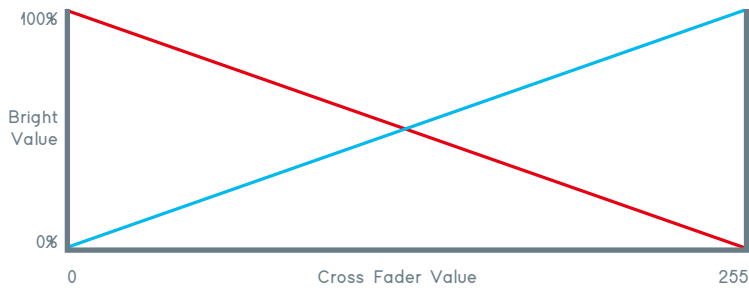

Color Macro

Channel 4 is Color Macro express rainbow gradation effect.

The order is **RED** > **GREEN** > **BLUE**

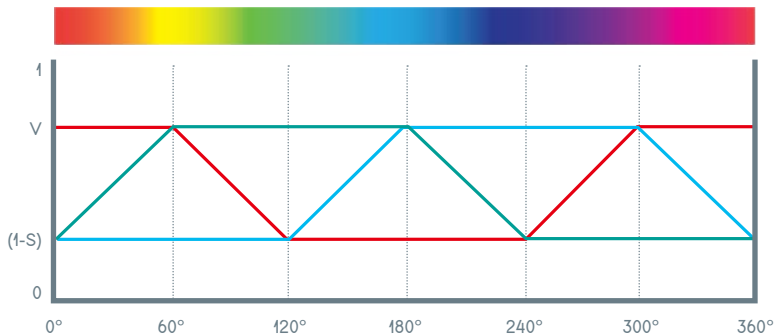

DMX Protocols (1/3) Channel Mode

Mode	Channel	DMX Value	%	Function
1	1	0-255	0-100	Dimmer

Mode	Channel	DMX Value	%	Function
3	1	0-255	0-100	Dimmer
	2	0-255	0-100	Color Temperature (CCT)
	3	0-119 / 120-255	See DMX Protocols (3)	Tint

Mode	Channel	DMX Value	%	Function
5	1	0-255	0-100	Dimmer
	2	0-255	0-100	Color Temperature (CCT)
	3	0-119 / 120-255	See DMX Protocols (3)	Tint
	4	0-255	0-100	Cross Fader
	5	0-255	0-100	Color Macro

Mode	Channel	DMX Value	%	Function
8	1	0-255	0-100	Dimmer
	2	0-255	0-100	Color Temperature (CCT)
	3	0-119 / 120-255	See DMX Protocols (3)	Tint
	4	0-255	0-100	Cross Fader
	5	0-255	0-100	Red
	6	0-255	0-100	Green
	7	0-255	0-100	Blue
	8	0-255	0-100	White

DMX Protocols (2/3)

Channel 2 : White Color Temperature

DMX Value	Function	DMX Value	Function	DMX Value	Function	DMX Value	Function	DMX Value	Function
0~1	2500	51~52	4000	102~103	5500	153~154	5500	204~205	5500
2~3	2550	53~54	4050	104~105	5550	155~156	5550	206~207	5550
4~5	2600	55~56	4100	106~107	5600	157~158	5600	208~209	5600
6	2650	57	4150	108	5650	159	5650	210	5650
7~8	2700	58~59	4200	109~110	5700	160~161	5700	211~212	5700
9~10	2750	60~61	4250	111~112	5750	162~163	5750	213~214	5750
11	2800	62	4300	113	5800	164	5800	215	5800
12~13	2850	63~64	4350	114~115	5850	165~166	5850	216~217	5850
14~15	2900	65~66	4400	116~117	5900	167~168	5900	218~219	5900
16	2950	67	4450	118	5950	169	5950	220	5950
17~18	3000	68~69	4500	119~120	6000	170~171	6000	221~222	6000
19~20	3050	70~71	4550	121~122	6050	172~173	6050	223~224	6050
21~22	3100	72~73	4600	123~124	6100	174~175	6100	225~226	6100
23	3150	74	4650	125	6150	176	6150	227	6150
24~25	3200	75~76	4700	126~127	6200	177~178	6200	228~229	6200
26~27	3250	77~78	4750	128~129	6250	179~180	6250	230~231	6250
28	3300	79	4800	130	6300	181	6300	232	6300
29~30	3350	80~81	4850	131~132	6350	182~183	6350	233~234	6350
31~32	3400	82~83	4900	133~134	6400	184~185	6400	235~236	6400
33	3450	84	4950	135	6450	186	6450	237	6450
34~35	3500	85~86	5000	136~137	6500	187~188	6500	238~239	6500
36~37	3550	87~88	5050	138~139	6550	189~190	6550	240~241	6550
38~39	3600	89~90	5100	140~141	6600	191~192	6600	242~243	6600
40	3650	91	5150	142	6650	193	6650	244	6650
41~42	3700	92~93	5200	143~144	6700	194~195	6700	245~246	6700
43~44	3750	94~95	5250	145~146	6750	196~197	6750	247~248	6750
45	3800	96	5300	147	6800	198	6800	249	6800
46~47	3850	97~98	5350	148~149	6850	199~200	6850	250~251	6850
48~49	3900	99~100	5400	150~151	6900	201~202	6900	252~253	6900
50	3950	101	5450	152	6950	203	6950	254	6950
								255	10000

DMX Protocols (3/3) Channel 3 : Tint

[Tint]

Mode	DMX Value	Output Value	Function
3	0~10	0	No Effect
	11~20	(-)1.00	Full Magenta
	21~119	(-)0.99 ~ (-)0.01	99~1% Magenta
	120~145	0	No Effect
	146~244	(+)0.01 ~ (+)0.99	1~99% Green
	245~255	(+)1.00	Full Green

RDM Protocols (1/3)

Parameter ID	Discovery command	SET command	GET command
DISC_UNIQUE_BRANCH	YES		
DISC_MUTE	YES		
DISC_UN_MUTE	YES		
DEVICE_INFO			YES
SUPPORTED_PARAMETERS			YES
SOFTWARE_VERSION_LABEL			YES
DMX_START_ADDRESS		YES	YES
IDENTIFY_DEVICE		YES	YES
DEVICE_MODEL_DESCRIPTION			YES
MANUFACTURER_LABEL			YES
DEVICE_LABEL		YES	YES
SENSOR_DEFINITION			YES
SENSOR_VALUE			YES
DMX_PERSONALITY		YES	YES
DMX_PERSONALITY_DESCRIPTION			YES
STATUS_MESSAGES			YES

RDM Protocols (2/3)

No	Device Property	Value (Example)	Description	User Setting	Remarks
1	Device Model Description	A6-PLUS	Model number of the device	Disable	
2	Manufacturer Label	ALPHA LITE	Name of the manufacturer	Disable	
3	Device Label	BASE123	Fixture name and management number	Enable	ex) Input : BASE123 · Name : BASE123 · Management # : 123 - Automatic recognition of up to 4 digits. If there is no number, the default is '001'.
4	Software Version Label	M0E-v1.10-v5.27-180928	Software version	Disable	
5	DMX Personality	1 Ch. Mode	DMX channel mode and color temperature setting	Enable	See (Table 1)
6	DMX Start Address	1	DMX address	Enable	1-512 Range
7	Device Hours	N/A		N/A	Display only, no actual response.
8	Lamp Hours	N/A		N/A	Display only, no actual response.
9	Lamp State	N/A		N/A	Display only, no actual response.
10	Lamp On Mode	N/A		N/A	Display only, no actual response.
11	Display Invert	On	LCD screen display direction	Enable	· Off : 0° · On : 180° · Auto : Current opposite direction
12	Identify Device	Off	Selected fixture blinking indication	Enable	· Off : Deactivates blinking · On : Activates blinking
13	Speed Set	15	Dimming delay Setting	Enable	0-40 range The larger the value, the slower the dimming.
14	Display Mode	0	Normal screen / Fixture ID screen transitions	Enable	· 0 : Normal screen · 1 : Fixture ID screen
15	Max. Temp	75	Fixture maximum temperature display	Enable	Use for initialization if necessary

[Lamp Controls]

No	Control Property	Value (Example)	Description	User Setting	Remarks
1	Identify On	N/A	Device identification action active	Enable	Identify device = Same as On
2	Identify Off	N/A	Device identification action inactive	Enable	Identify device = Same as Off
3	Cold Reset	N/A	Device reset(restart)	Enable	Same as Warm reset
4	Warm Reset	N/A	Device reset(restart)	Enable	Same as Cold reset

RDM Protocols (3/3)

[Sensor]

No	Device Sensors	Value (Example)	Description	User Setting	Remarks
1	Sensor Temp	64°C	Current fixture temperature	Disable	

[Error Message]

No	Condition	Level	Description	Display
1	Sensor Over Temp	Warning	Fixture temperature 46 ~ 69°C	Orange message
2	Sensor Over Temp	Error	Fixture temperature over 70°C	Red message

[Table 1]

Model	Value	Description
8 Ch. Model Device (Variable Color Temperature & RGB)	1 Ch. Mode	1 Ch. Mode
	3 Ch. Mode	3 Ch. Mode
	5 Ch. Mode	5 Ch. Mode
	8 Ch. Mode	8 Ch. Mode
	1 Ch. 2500K	1 Ch. Mode + 2500K Color Temperature
	1 Ch. 2900K	1 Ch. Mode + 2900K Color Temperature
	1 Ch. 3000K	1 Ch. Mode + 3000K Color Temperature
	1 Ch. 3500K	1 Ch. Mode + 3500K Color Temperature
	1 Ch. 4000K	1 Ch. Mode + 4000K Color Temperature
	1 Ch. 4500K	1 Ch. Mode + 4500K Color Temperature
	1 Ch. 5000K	1 Ch. Mode + 5500K Color Temperature
	1 Ch. 5600K	1 Ch. Mode + 5600K Color Temperature
	1 Ch. 6000K	1 Ch. Mode + 6000K Color Temperature
	1 Ch. 10000K	1 Ch. Mode + 10000K Color Temperature