



00000000 0000

FS3000



Precautions

[WARNING]

1

Do not open or disassemble the cover to reduce the risk of electric shock.

2

Please wear safety equipment such as safety helmet during work.

3

Be sure to fix the safety chain on the product when installing and moving.

4

Please install the signs below for people to bypass when install the product on high truss.

5

The work should be done under the direction of approved specialist who is trained in safety and mechanical installations.

6

The brightness and color temperature before and after aging may be different.

Contents

Safety Information	1
--------------------------	---

Fixture Information

Fixture Information	3
Fixture Exterior View	4
Dimensions	5
Accessory Options	6
Technical Specifications	7
Photometry Data	8

Fixture Installation

Power Connection	9
DMX Connection	10

LCD Screen Instruction

Unlocking	11
Screen Instruction	12
Menu Tree	13
Main Screen by Mode	14
& Product Information	
DMX Mode	15
(Channel Change & Address Setup)	
User Mode	16
(Intensity & Color Temperature Adjust)	

Extra Function

Sleep Mode Function	17
RDM Function	
Dimming Speed Setup	
Master Function	18
Fixture ID Number Setup	19
Device Label Setup	

Error Information

Temperature Sensor	20
Network Connection	

Protocols

DMX Protocols	21
RDM Protocols	23



Product name.

FS3000

FS Series is SPOT lighting that uses a multi-focusing zoom lens based on ALPHA LITE's unique technology, and there is no yellowing phenomenon at the boundary of illuminated light by multifocal LED and no color temperature change by chromatic aberration.

FS Series uses a large-capacity/single light source to express the light source texture similar to the halogen lamp. Also, the boundary of the shadow is formed smoothly sharpness.

Beam cutting is excellent by adjusting the angle of the barn door.

FS Series is light weight compare to capacity, and designed sturdy housing.

By applying the wireless DMX communication, user can easily set up lighting fixtures without a signal cable. The Smart Touch LCD controller can use functions such as intuitive operation and address display on the screen in consideration of user convenience.

Also, the housing is designed for easy maintenance and repair.

Fixture Exterior View

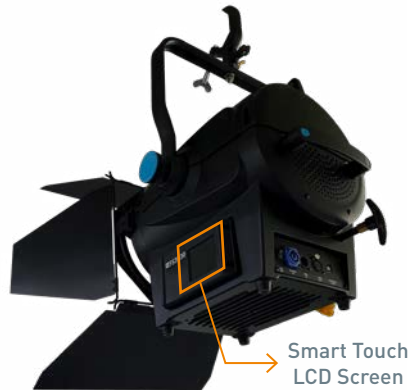

Dimensions

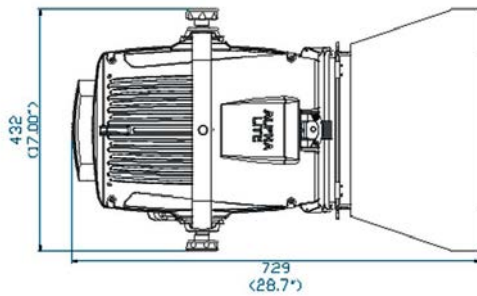
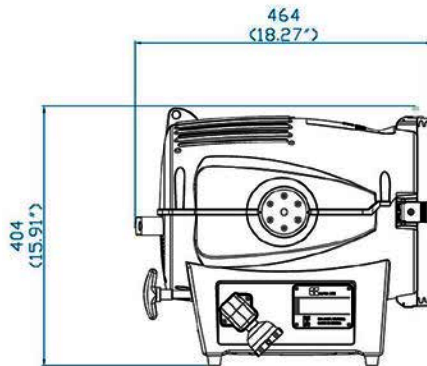
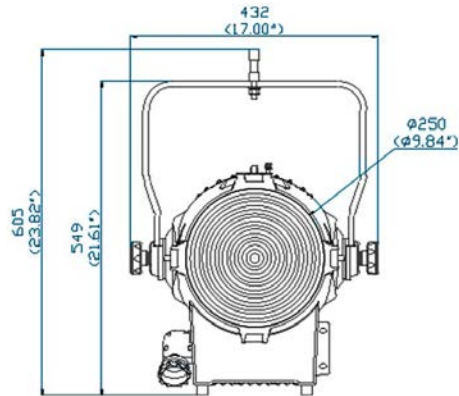

Accessory Options



Pole operation yoke

· Pan & Tilt



Jemball

· Detachable



Soft box

· Detachable

Technical Specifications

LED Chip Type	600W CSP LED
Estimated LED Lifetime (hours)	50,000
White Light (K)	2,900–6,000K (VCT)
Color Rendition (%)	CRI 98 / TLCI 98
Dimming (%)	0–100 (16-bit)
Lens Diameter (mm/inch)	250 / 9.8
Beam Angle (°)	15–55
Signal Control	5-Pin DMX In and Out
Individual Control	Smart Touch LCD Controller
Supported Protocol	DMX512 / RDM
(Optional) Supported Protocol	DMX512 Wireless / RDM Wireless
Remote Device Management	Supported
Channel Function	Dimming / CCT
Power Input Voltage	AC 100–240V / 50–60Hz
Power Consumption (W)	500
Ambient Temperature Operation (°C)	-20–45
Spigot Mounting (mm)	16 / 28
Tilt Angle (°)	+ / - 90
Body Dimensions (mm/inch) (WHD)	328 x 404 x 464 / 12.9 x 15.9 x 18.3
Full Dimensions with Manual Yoke (mm/inch) (WHD)	432 x 605 x 464 / 17 x 23.8 x 18.3
Body Weight (kg/lbs)	12.3 / 27.1
Full Weight with Manual Yoke (kg/lbs)	13.8 / 30.4
Protection Class	IP20

* This specification data is based on the aging state of the equipment, and the brightness and color temperature before and after aging may be different.

Photometry Data

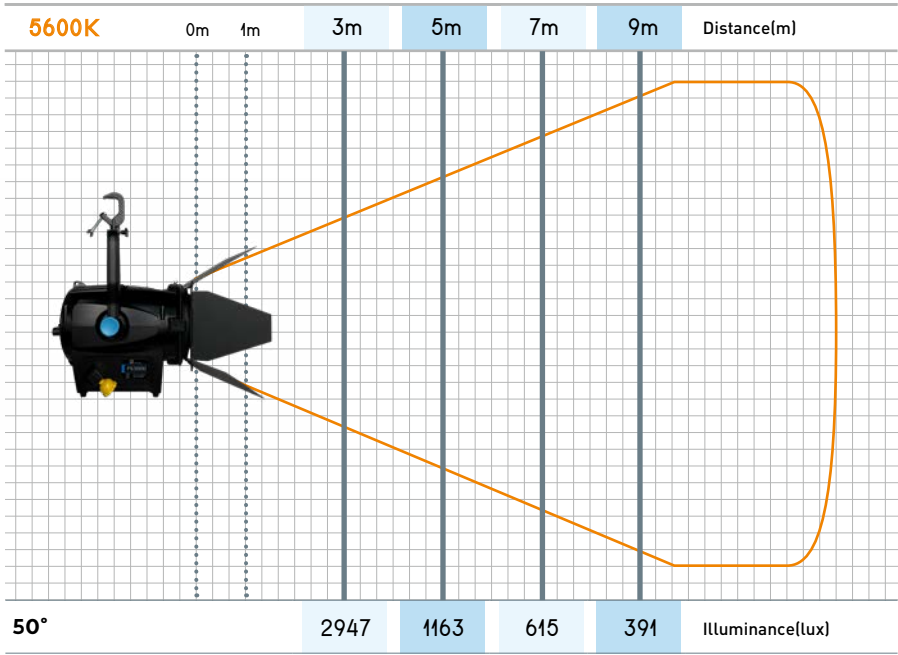

Power Connection

AC power at 100-240V, 50-60Hz

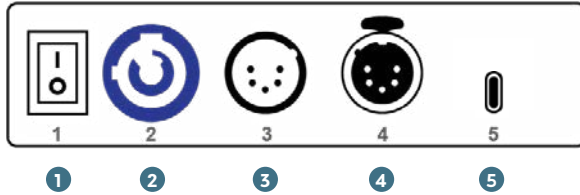

① POWER ON/OFF SWITCH

② POWER IN

③ DMX IN

④ DMX OUT

⑤ C-TYPE PORT
(for ADMINISTRATOR ONLY)

※ Do not connect USB without administrator's permission.

- ⚠ WARNING**
1. Observe the proper voltage rang.
 2. If power is supplied outside the range, noise may be generated from the SMPS.
 3. If the operating voltage is out of the proper voltage range, SMPS function may be degraded or damaged.

DMX Connection

3-pin or 5-pin XLR sockets are equipped for DMX input and output, depending on user needs.

Connect the controller to a lighting, or lighting fixture to other lighting fixture. If user uses a standard DMX controller, the DMX output of the controller can connect directly to the DMX input of the first fixture in the DMX chain.

User must use an adapter cable for connect the DMX controller to other XLR output.

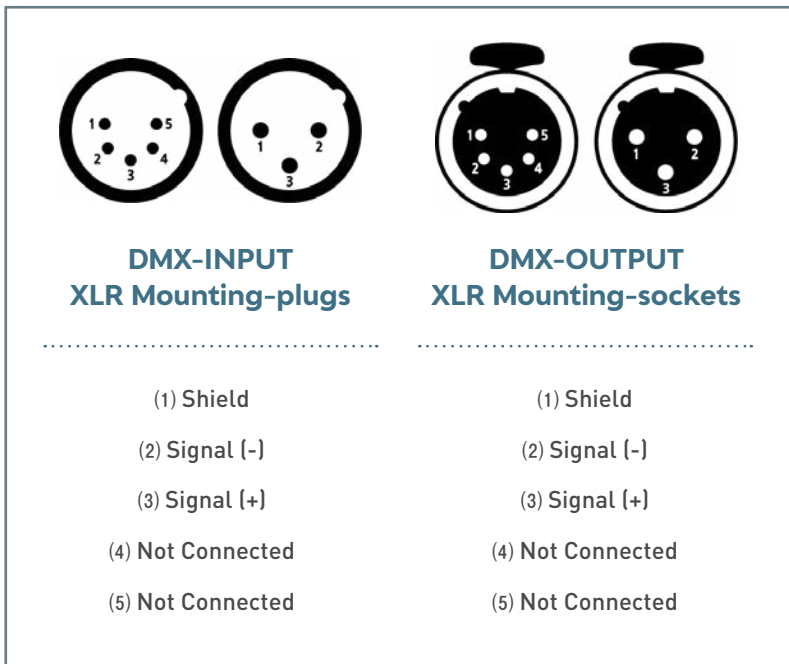

- WARNING**
1. Connect the DMX output of the first lighting fixture in DMX chain to the DMX input of the next fixture.
 2. Connect one output to the input of the next fixture until all fixtures are connected.
 3. In the last lighting fixture, the DMX cable must be end with a terminator (120 Ω resistor) in DMX output signal (+, -).

Unlocking

When the fixture is turned on, the Smart Touch screen automatically locked. To unlock the touch screen, touch the finger icon (A) three times. If you do not touch for 30 seconds, the lock is reset.

[Main Screen (Locked)]

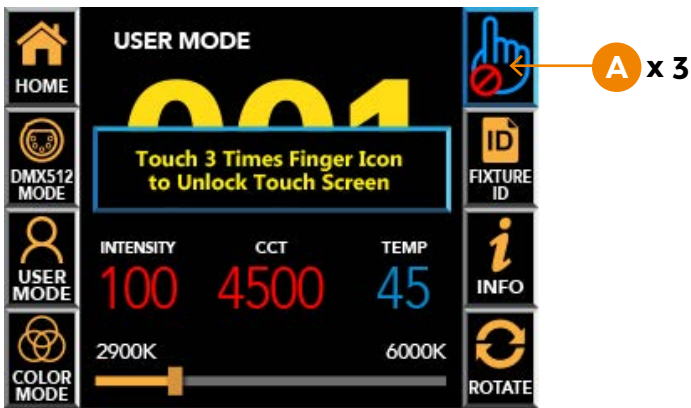

[Fixture ID Screen (Locked)]

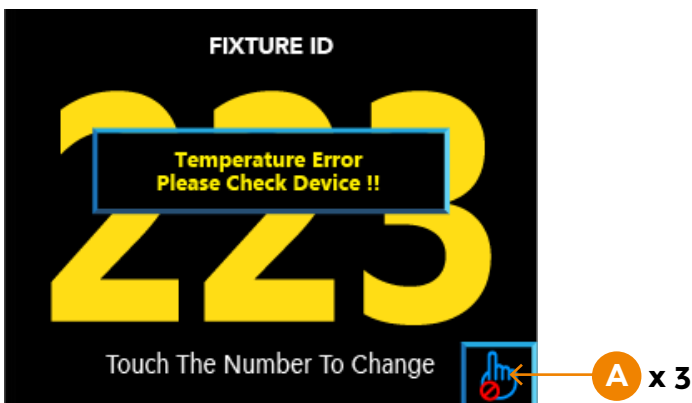

Screen Instructions

[Main Screen (Unlocked)]

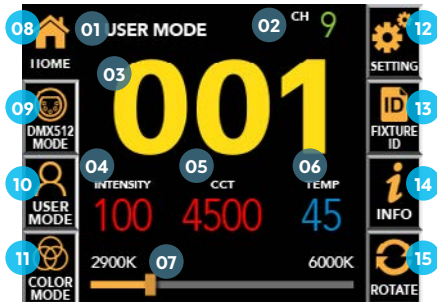

[Setting Screen]

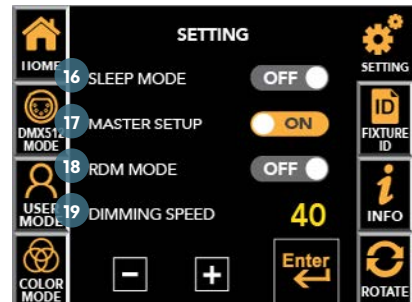

01	Current Mode	Display DMX MODE or USER MODE or COLOR MODE.
02	Current Channel Mode	Display current channel mode. <i>*Only display on DMX MODE</i>
03	DMX512 Address	Display current DMX512 Address.
04	Brightness (Intensity)	Displays the brightness value(0~100%) of the equipment.
05	CCT (Correlated Color Temperature)	Displays the color temperature(2900~6000K) of the equipment.
06	Fixture Current Temperature	The current temperature of the instrument is detected and displayed in °C.
07	(In USER MODE) Activated function control bar	Adjust the selected function among Intensity and Color Temperature.
	(In DMX MODE) Current channel mode	Display current channel mode. <i>*Only display on DMX MODE</i>
08	Home	Return to the main screen
09	DMX512 Mode & Address Setup	Set channel mode and DMX512 address
10	User Mode Setup	Set 'Intensity' and 'CCT' manually.
11	Color Mode Setup <i>(No applicable model)</i>	Set 'RGB' lighting color, 'Saturation', and 'Intensity'
12	Setting	Setting or changing the function of the equipment.
13	Fixture ID	Displays numbers for equipment management.
14	Equipment Information	Displays the help that describes the screen.
15	Screen Rotation	LCD screen is rotated 180° for each touch.
16	Sleep Mode Setup	Activate and deactivate LCD Auto off function
17	Master Setup	Activate and deactivate Master function
18	RDM Mode Setup	Activate and deactivate RDM function
19	Dimming Speed Setup	Set dimming speed

Menu Tree

- ⊖ Home [Main screen]
 - ⊖ DMX512 Mode
 - DMX mode select
 - DMX address input
 - ⊖ Information
 - DMX channel value
 - ⊖ User Mode
 - Intensity setup
 - Color temperature setup
 - Tint setup No applicable model
 - ⊖ Information
 - Description of each function
 - ⊖ Color Mode No applicable model
 - RGB color setup
 - Saturation setup
 - White setup
 - ⊖ Full screen
 - Individual RGB setup and Preset
 - ⊖ Information
 - RGBW value
 - ⊖ Setting
 - Sleep mode setup
 - Master function setup
 - RDM mode setup
 - Dimming speed setup
 - ⊖ Information
 - Description of each function
 - ⊖ Fixture ID
 - ⊖ Fixture ID screen
 - Fixture ID number input
 - ⊖ Information
 - Description of fixture ID
 - ⊖ Information
 - Basic equipment information
 - ⊖ Rotate

Main Screen by Mode & Product Information

001 Main Screen by Mode Information

HOME

DMX MODE

USER MODE

COLOR MODE

The current mode is displayed in the upper left corner of the main screen among DMX MODE, USER MODE and COLOR MODE (No applicable model), and the DMX address number of the equipment is displayed in the middle with a yellow number. At the bottom, the current lighting value and fixture temperature are displayed, and some lighting value can be adjusted on the main screen by touching the value.

[DMX MODE]



[USER MODE]



[COLOR MODE]

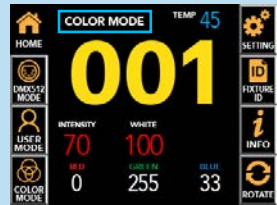

Product Information

HOME

INFO

Product model name, firmware version, UID number, current temperature of equipment, usage time of equipment, LED usage time, website, manual download link, etc. by clicking the INFO button on the main screen.

Each 'MENU' ▶ Touch the 'INFO' ▶ User can check the menu description and functions.

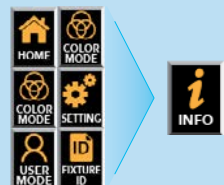

DMX Mode Channel Change & Address Setup

DMX MODE : It is used to adjust value by DMX512 signal.

HOME

DMX512 MODE

Move to the DMX channel change screen.

In DMX512 MODE screen, user can select DMX channel mode on top tap.

▶ Input DMX512 address by pressing the number pad.

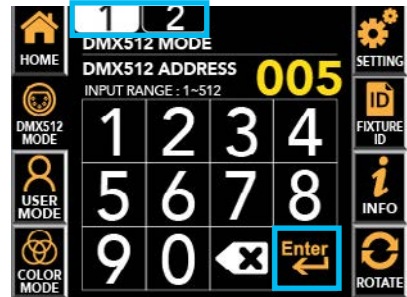
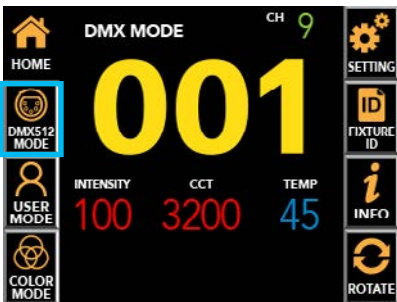

DMX512 MODE SCREEN

INFO

Displays each channel information and value.

※ To return to the previous screen, press the 'INFO' button again.

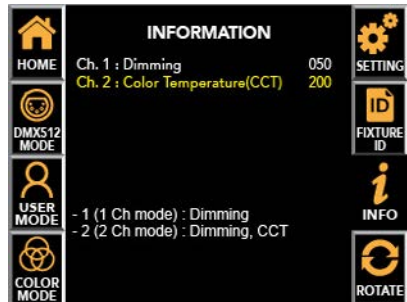
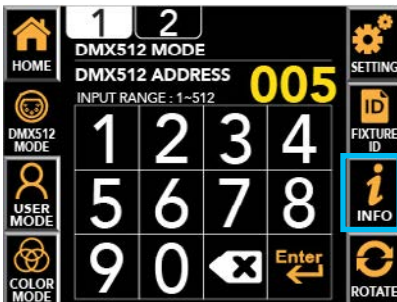

Information

- 1 (1 Ch Mode) : Dimming - 2 (2 Ch Mode) : Dimming, CCT

* Support channels and features vary by product.

User Mode Setup & Intensity / CCT Adjust

* If the equipment does not support COLOR MODE, the Tint function does not work.

USER MODE : It is used when the user directly manipulates the equipment.

HOME

USER MODE

Move to user-operable screen to change Intensity/CCT.

OR

'Current Intensity'
'Current CCT'

Activate control bar and adjust value directly according to selected function.

※ In DMX mode, even if you press the current value on the main screen, the bottom bar is not active.

USER MODE screen ▶ Touch the function you want to change ▶ **Active in Orange** ▶ Adjust the value with touch or drag.

Drag the activated bar close to the desired value, and then touch \uparrow , \downarrow to set the exact value.

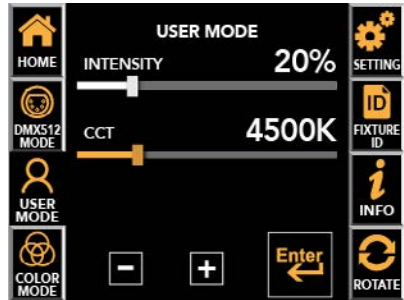
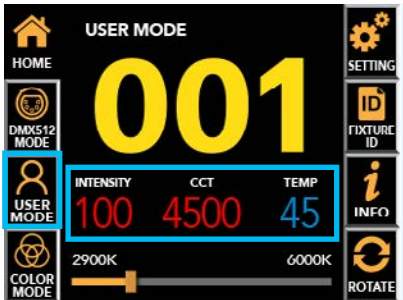

USER MODE SCREEN

INFO

Displays description of each function.

※ To return to the previous screen, press the 'INFO' button again.

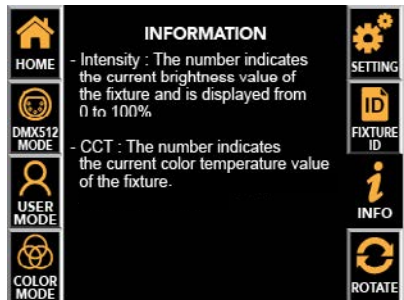
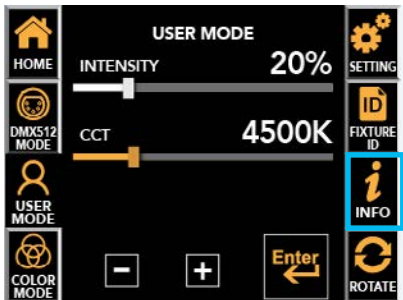

Information

- Intensity : The number indicates the current brightness value of the fixture and is displayed from 0 to 100%.

- CCT : The number indicates the current color temperature value of the fixture and is displayed from 2,900~6,000Kelvin.

Extra Function

- Sleep Mode / Master / RDM / Dimming Speed

HOME

SETTING

Move to additional settings other than the main icon.

SETTING screen ▶ Touch ON/OFF the function you want to change among SLEEP MODE, MASTER, and RDM MODE ▶ **Active in Orange** ▶ Set ON/OFF

- DIMMING SPEED SETUP can be activated by touching, and press **+**, **-** to adjust the value.



SETTING SCREEN

INFO

Displays description of each function.

※ Press the INFO button again to return to the setting screen.

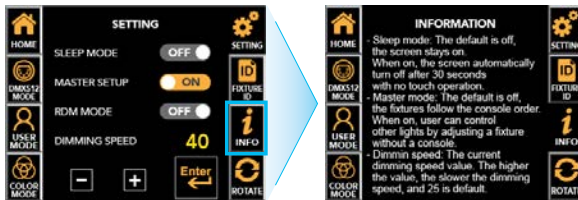

Information

- **Sleep mode setup (Default=Off)** : The function to automatically turn off the screen when there is no operation for 30 seconds. If OFF, it is always on the screen while power is on.
- **Master setup (Default=Off)** : The function to synchronize and user control all connected fixtures without a console connection. If OFF, the DMX signal will follow.
- **RDM setup (Default=On)** : The function to enable two-way wireless communication through RDM equipment. If OFF, it is not detected by RDM equipment.
- **Dimming speed setup** : The number indicates the current dimming speed value of the fixture and is displayed from 0 to 40. The higher the value, the slower the dimming speed, and '15' is default speed.

Extra Function

- Sleep Mode / Master / RDM / Dimming Speed

Master Setup

- The master slave function allows to synchronize and control all connected lighting fixtures through the DMX signal without a console connection.
- If a problem occurs in the console or communication line, it is possible to control the brightness and CCT and color with only the lighting fixture.
- Main screen ► Setting ► Touch MASTER SETUP, the function turns on. (2 Touch)
- Functions available with one setting of the first lighting fixture.

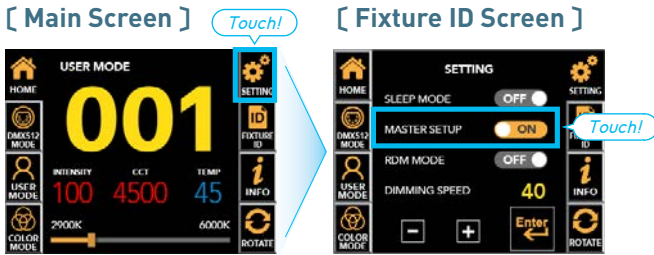

ex

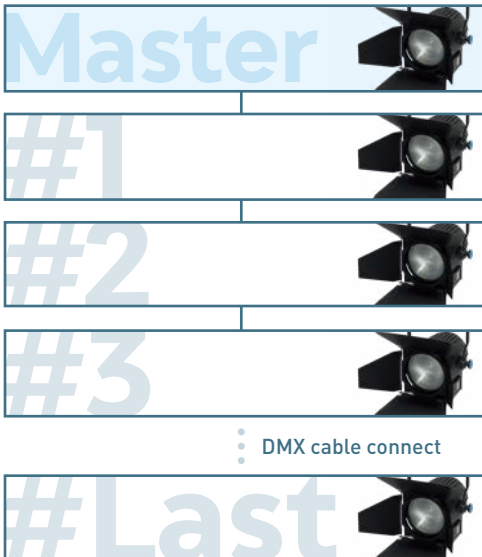

- Remove 'DMX in' cable.
 - Set '**Master Enable**'
 - Set the same channel mode.
 - Operation After setting.

- Connecting 'DMX in & out' cable.
 - Set '**Master Disable**'
 - Set the same channel mode.
 - No operation after setting.

Fixture ID & Label Setup

HOME

FIXTURE ID

Move to fixture management number setting screen.

Move to input screen that can change the number ▶ Input the desired number 001 to 9999 and press Enter ▶ Move to the FIXTURE ID screen that displays the large size entered value ▶ Touch HOME icon to go back to the main screen.

[Main Screen]

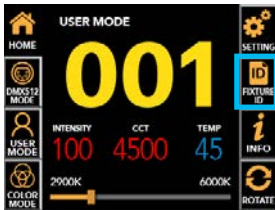

[Fixture ID Screen]

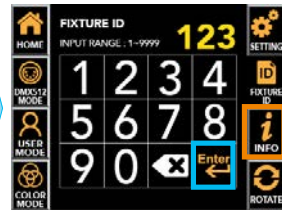

[Fixture ID Input Screen]

Fixture ID
Input
Screen

INFO

Displays description of each function.

※ It is the number value 001 to 9999 for the management of the lighting fixture can be changed by manual or RDM device.

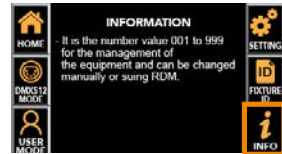

[Device Label Setup]



[Change the device label through RDM]

《 The device label is basically the model name. It can be changed through RDM communication, but it can't be changed through the Smart Touch LCD 》

Enter the device name and the management number in the 'Device Label' field. ▶ The entered contents are displayed in the upper left corner.

- The fixture ID is displayed in 3 or 4 digits from automatically recognized 4 digits in contents.
- If user do not enter any number, the fixture ID is displayed as '001'.

	ex 1	ex 2	ex 3	ex 4	ex 5
Input(Device Label in RDM)	SPOT123	SPOT1234	SPOT12345	SPOT	STUDIO13-23
Fixture Label(in Fixture)	SPOT123	SPOT1234	SPOT12345	SPOT	STUDIO13-23
ID Number(in Fixture)	123	1234	2345	001	023

Error Information

Temperature Sensor

Detects the temperature of the current fixture(LED source, housing) and displays it on the Smart Touch LCD screen.



If it exceeds 85°C, the actual LED output will be 0%, and

“Temperature Error!!”

“Please Check Device!!”

will be displayed.

The error messages are only displayed on the main screen and the fixture ID screen. Even if the temperature falls to the normal range, It does not disappear.

In this case, normalize the temperature of the equipment and restart it.

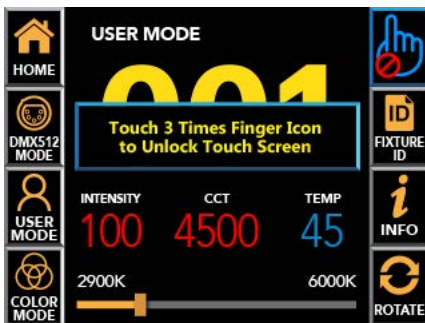

Network Connection

When the DMX512 network connection is lost, the DMX512 address number on main screen and the fixture ID screen blinks. Reconnect after checking the connection status.

DMX Protocols (1/2) Channel Mode

Mode	Channel	DMX Value	%	Function
1	1	0-255	0-100	Dimmer

Mode	Channel	DMX Value	%	Function
2	1	0-255	0-100	Dimmer
	2	0-255	0-100	Color Temperature(CCT)

DMX Protocols (2/2)

2 Channel Mode : White Color Temperature

DMX Value	Function
0~255	Dimmer 0~100%
0~3	2900K
4~7	2950K
8~11	3000K
12~15	3050K
16~19	3100K
20~23	3150K
24~27	3200K
28~31	3250K
32~35	3300K
36~39	3350K
40~43	3400K
44~47	3450K
48~51	3500K
52~55	3550K
56~59	3600K
60~63	3650K
64~67	3700K
68~71	3750K
72~75	3800K
76~79	3850K
80~83	3900K
84~87	3950K
88~91	4000K
92~95	4050K
96~99	4100K
100~103	4150K
104~107	4200K
108~111	4250K
112~115	4300K

DMX Value	Function
116~119	4350K
120~123	4400K
124~127	4450K
128~131	4500K
132~135	4550K
136~139	4600K
140~143	4650K
144~147	4700K
148~151	4750K
152~155	4800K
156~159	4850K
160~163	4900K
164~167	4950K
168~171	5000K
172~175	5050K
176~179	5100K
180~183	5150K
184~187	5200K
188~191	5250K
192~195	5300K
196~199	5350K
200~203	5400K
204~207	5450K
208~211	5500K
212~215	5550K
216~219	5600K
220~223	5650K
224~227	5700K
228~231	5750K
232~235	5800K

DMX Value	Function
236~239	5850K
240~243	5900K
244~247	5950K
248~255	6000K

RDM Protocols (1/3)

Parameter ID	Discovery command	SET command	GET command
DISC_UNIQUE_BRANCH	YES		
DISC_MUTE	YES		
DISC_UN_MUTE	YES		
DEVICE_INFO			YES
SUPPORTED_PARAMETERS			YES
SOFTWARE_VERSION_LABEL			YES
DMX_START_ADDRESS		YES	YES
IDENTIFY_DEVICE		YES	YES
DEVICE_MODEL_DESCRIPTION			YES
MANUFACTURER_LABEL			YES
DEVICE_LABEL		YES	YES
SENSOR_DEFINITION			YES
SENSOR_VALUE			YES
DMX_PERSONALITY		YES	YES
DMX_PERSONALITY_DESCRIPTION			YES
STATUS_MESSAGES			YES

[Lamp Controls]

No	Control Property	Value (Example)	Description	User Setting	Remarks
1	Identify On	N/A	Device identification action active	Enable	Identify device = Same as On
2	Identify Off	N/A	Device identification action inactive	Enable	Identify device = Same as Off
3	Cold Reset	N/A	Device reset(restart)	Enable	Same as Warm reset
4	Warm Reset	N/A	Device reset(restart)	Enable	Same as Cold reset

RDM Protocols (2/3)

No	Device Property	Value (Example)	Description	User Setting	Remarks
1	Device Model Description	FS3000	Model number of the device	Disable	
2	Manufacturer Label	ALPHA LITE	Name of the manufacturer	Disable	
3	Device Label	SPOT123	Fixture name and management number	Enable	ex) Input : SPOT123 · Name : SPOT123 · Management # : 123 - Automatic recognition of up to 4 digits. If there is no number, the default is '001'.
4	Software Version Label	M0E-v1.10-v5.27-180928	Software version	Disable	
5	DMX Personality	1 Ch. Mode	DMX channel mode and color temperature setting	Enable	See [Table 1]
6	DMX Start Address	1	DMX address	Enable	1-512 Range
7	Device Hours	N/A		N/A	Display only, no actual response.
8	Lamp Hours	N/A		N/A	Display only, no actual response.
9	Lamp State	N/A		N/A	Display only, no actual response.
10	Lamp On Mode	N/A		N/A	Display only, no actual response.
11	Display Invert	On	LCD screen display direction	Enable	· Off : 0° · On : 180° · Auto : Current opposite direction
12	Identify Device	Off	Selected fixture blinking indication	Enable	· Off : Deactivates blinking · On : Activates blinking
13	Speed Set	15	Dimming delay Setting	Enable	0-40 range The larger the value, the slower the dimming.
14	Display Mode	0	Normal screen / Fixture ID screen transitions	Enable	· 0 : Normal screen · 1 : Fixture ID screen
15	Max. Temp	75	Fixture maximum temperature display	Enable	Use for initialization if necessary

RDM Protocols (3/3)

[Sensor]

No	Device Sensors	Value (Example)	Description	User Setting	Remarks
1	Sensor Temp	64°C	Current fixture temperature	Disable	

[Error Message]

No	Condition	Level	Description	Display
1	Sensor Over Temp	Warning	Fixture temperature 46 ~ 69°C	Orange message
2	Sensor Over Temp	Error	Fixture temperature over 70°C	Red message

[Table 1]

Model	Value	Description
2 Ch. Model Device (Variable Color Temperature)	1 Ch. Mode	1 Ch. Mode
	2 Ch. Mode	2 Ch. Mode
	1 Ch. 2900K	1 Ch. Mode + 2900K Color Temperature
	1 Ch. 3000K	1 Ch. Mode + 3000K Color Temperature
	1 Ch. 3100K	1 Ch. Mode + 3100K Color Temperature
	1 Ch. 3200K	1 Ch. Mode + 3200K Color Temperature
	1 Ch. 4400K	1 Ch. Mode + 4400K Color Temperature
	1 Ch. 4500K	1 Ch. Mode + 4500K Color Temperature
	1 Ch. 5500K	1 Ch. Mode + 5500K Color Temperature
	1 Ch. 5600K	1 Ch. Mode + 5600K Color Temperature
	1 Ch. 5700K	1 Ch. Mode + 5700K Color Temperature
	1 Ch. 6000K	1 Ch. Mode + 6000K Color Temperature



ALPHA LITE USER MANUAL BOOK

—

<Tel> 82-2-6317-0464

<Fax> 82-2-2039-0464

<E-mail> hello@alpha-lite.net

<Web> www.alpha-lite.net