

# DL100

## ALPHA LITE LED Downlight Data Sheet

### Fixture Information

- Angle adjustable
- High color rendering of CRI 90 or higher
- COB LED Chip
- All-in-one Main drive controller
- RDM network communication possible
- Maintain the last signal when DMX signal is lost
- Dimming curve selectable (Linear & curve dimming)



Ultra HD  
Lighting Quality



High CRI  
True Color



High TLCI  
True Color



Flicker Free



Long LED  
Lifetime



Quiet  
(No Fan)



Adjustable



DL100  
DATA SHEET

## Specifications

LED Chip Type	100W
Estimated LED Lifetime (hours)	50,000
White Light (K)	3000 / 3200 / 5600 (FCT)
Color Rendition (%)	CRI 90 / TLCI 90
Dimming (%)	0-100 (16-bit)
Cut-off Size Diameter (mm/inch)	205-230 / 8.1-9.1
Beam Angle (°)	30 / 40 / 65
Tilt (°)	27
Signal Control	3-Pin DMX In and Through
Individual Control	Dip Switch
Supported Protocol	DMX512
(Optional) Supported Protocol	DMX512 Wireless
Remote Device Management	Not Supported
Channel Function	Dimming
Power Input Voltage	AC 100-277V
Power Consumption (W)	85
Ambient Temperature Operation (°C)	-20-45
Body Dimensions (mm/inch) (WHD)	ø250 x 165 / ø9.8 x 6.5
Body Weight (kg/lbs)	1.55 / 3.4
Protection Class	IP20

## Dimension

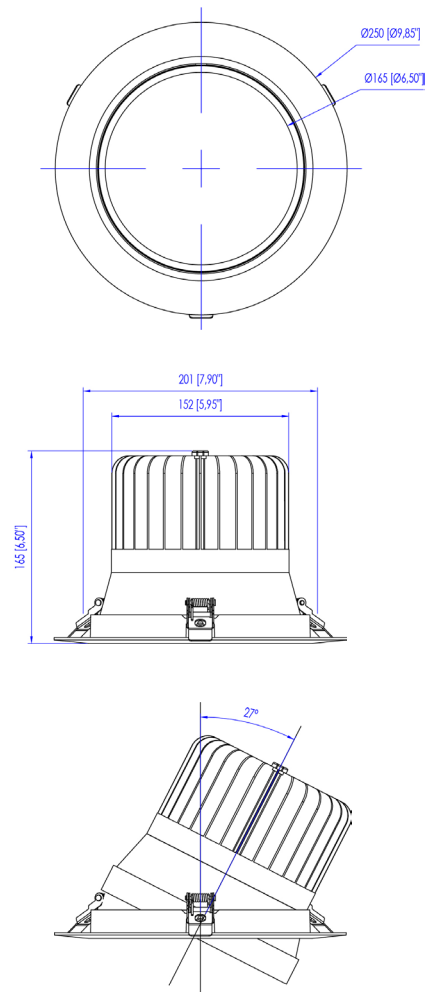

## Luminous Intensity Distribution Diagram

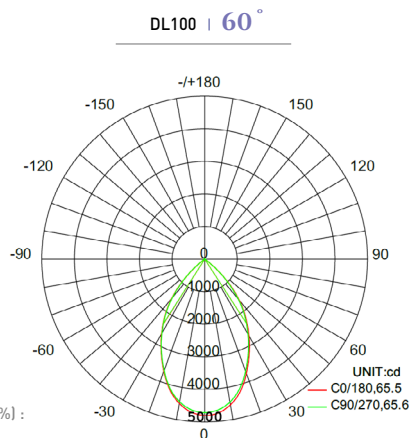

WWW.ALPHA-LITE.NET

